

WALLOTHNESCH.COM

AUTOMATIC FRONT SEAT BELT

FITTING INSTRUCTION

Before fitting the belt to the car please read through carefully.

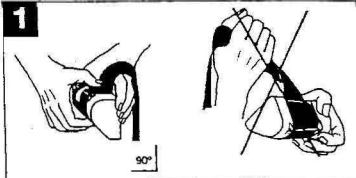

The 3-point safetybelt with slide action buckle and dual sensitive emergency locking retractor is supplied with the fitting kit components
Depending on the assembly conditions not all components have to be used sometimes
The standard fitting points can be found by using the owner's manual
Usually these points are closed with plastic plugs which have to be removed

DOOR PILLAR FITTING - Point A

According to picture A. If there should be several points select the most convenient one.
Mount the running loop bracket as to picture A and take care that the bracket can swivel freely.

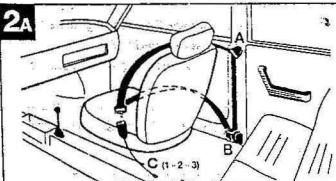

FITTING OF THE REEL - Point B'

During transport and unpacking the reel can lock. To release the locking mechanism put the reel into a vertical position according to picture 1. If it is still locking pull out the webbing slowly but strongly. Then let the webbing go. Thereafter you can pull out the webbing slowly.

Check the seat belts fitting points reading the instructions booklet of your car - picture 5

If there is a standard fitting point assemble according to picture 7. Use components in correct sequence.

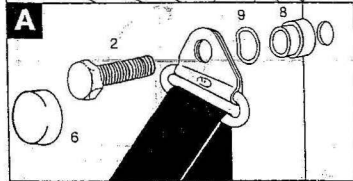
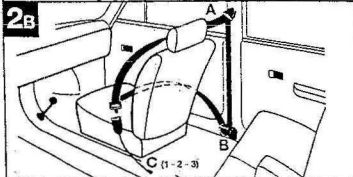

The reel has to be mounted in a vertical and horizontal position.

Deviations are not allowed to be more than 5°
Check the free run of the webbing coil after assembly

SLIDE ACTION BUCKLE FITTING - Point C

You will find standard fitting point either in the tunnel or in the car body floor. Assemble according to picture C1, C2 or C3. The red-orange "PRESS" key should be mounted so that it is located to the car centre. You can bend the plastic wire into the correct position.

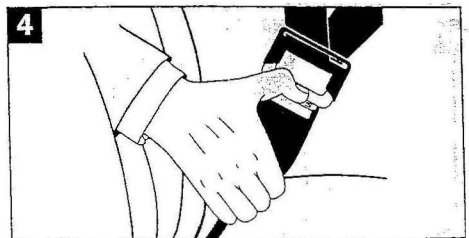
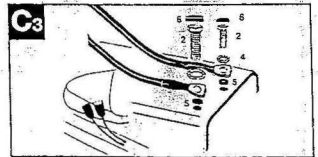
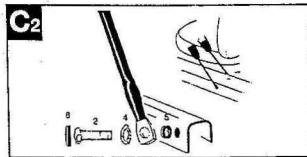
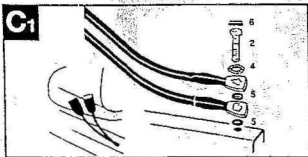

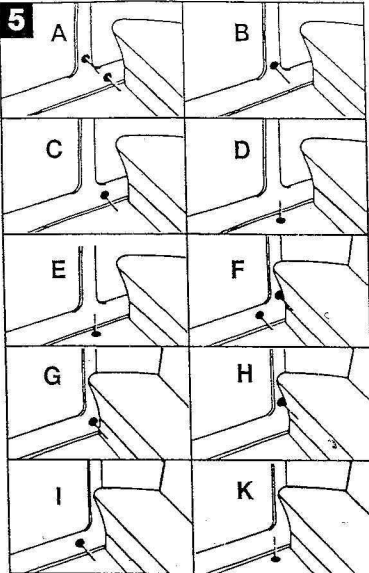

USING INSTRUCTION

PUTTING ON THE BELT

Put the metal buckle tongue into the buckle until it engages audibly. The webbing length is controlled by the reel and allows total freedom of movement.

BUCKLE RELEASE

Press the red-orange key and the buckle tongue will be ejected so that the reel winds up the webbing.

FUNCTION OF THE REEL

The reel is dual sensitive.

1. Webbing sensitivity: the reel reacts on a sudden pullout of the webbing. Therefore it is essential to pull out the webbing slowly during the fastening of the seat belt.
2. Vehicle sensitivity: the reel reacts on braking, crashes and rollovers as well as hard curve driving. Therefore, the mechanism can lock also when you tilt the car.

CLEANING OF THE WEBBING

With mild detergents.

FURTHER RECOMMENDATIONS

Don't twist the webbing. Avoid sharp edges which could damage the webbing. If wear can be observed either on brackets or on webbing replace the belt immediately.

The reel is not allowed to be opened otherwise the function can no longer be guaranteed. Replace the belt after an accident.

This belt is being outlined for an adult. Children under the age of 12 should be secured with this belt only together with a proper child seat. Ask your garagist! Each belt configuration is government approved. Modifications are forbidden.

6

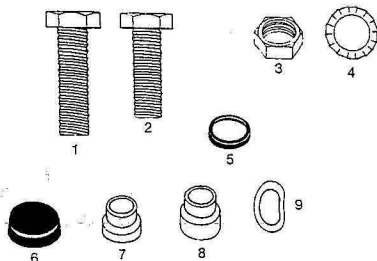

7

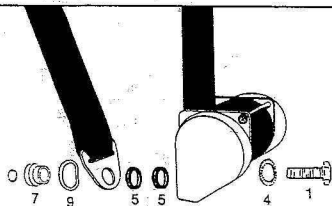

FULL EXTRACTION: 3250mm ±20

600mm ±10

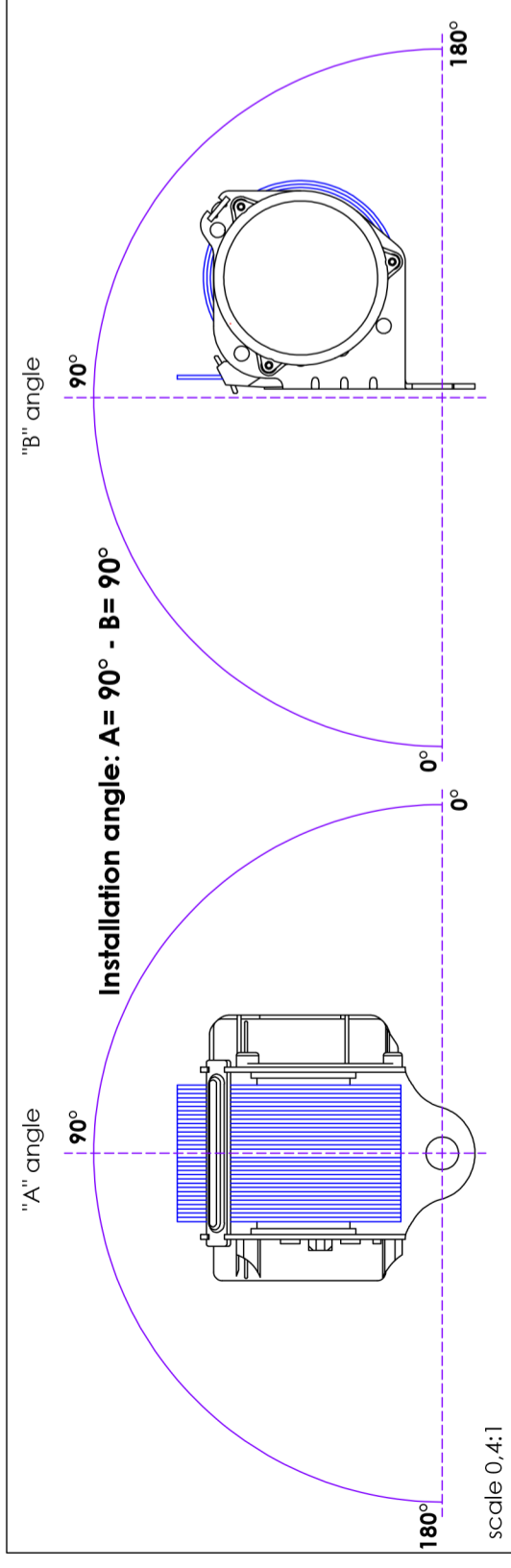
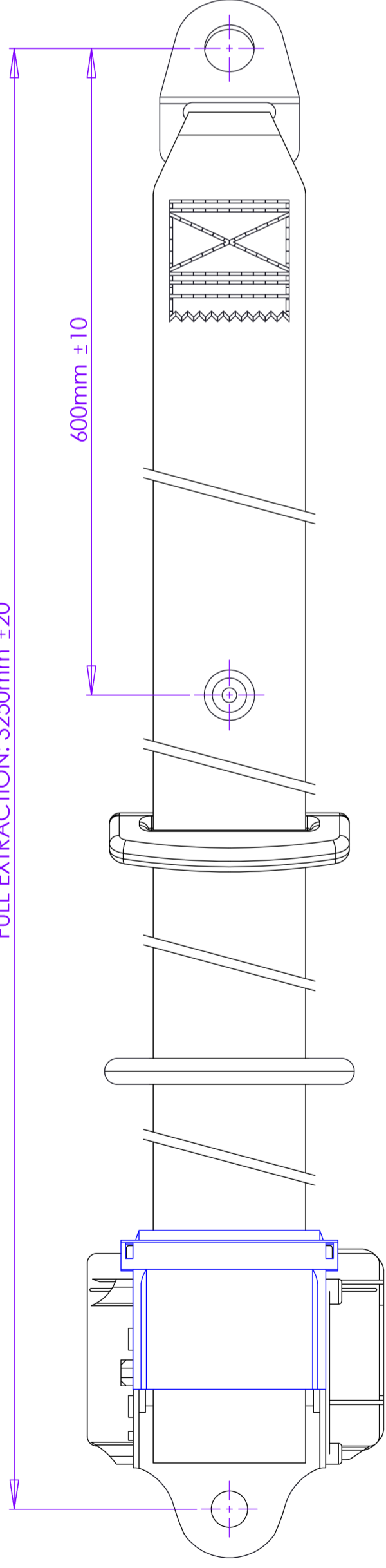

scale 0.4:1

HOMOLOGATION LABEL

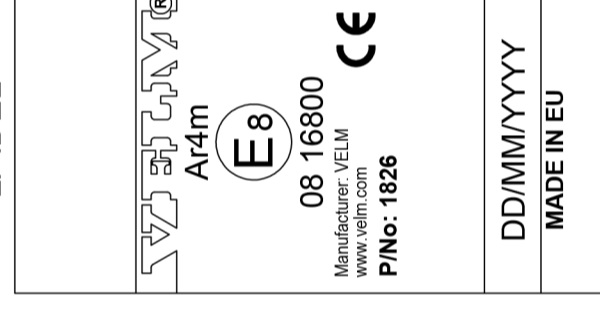

COVER 999912800

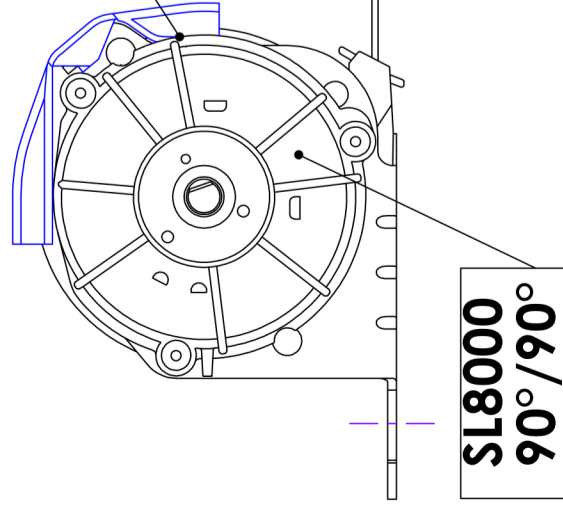

Metal pillar loop 99999122

HOMOLOGATION LABEL

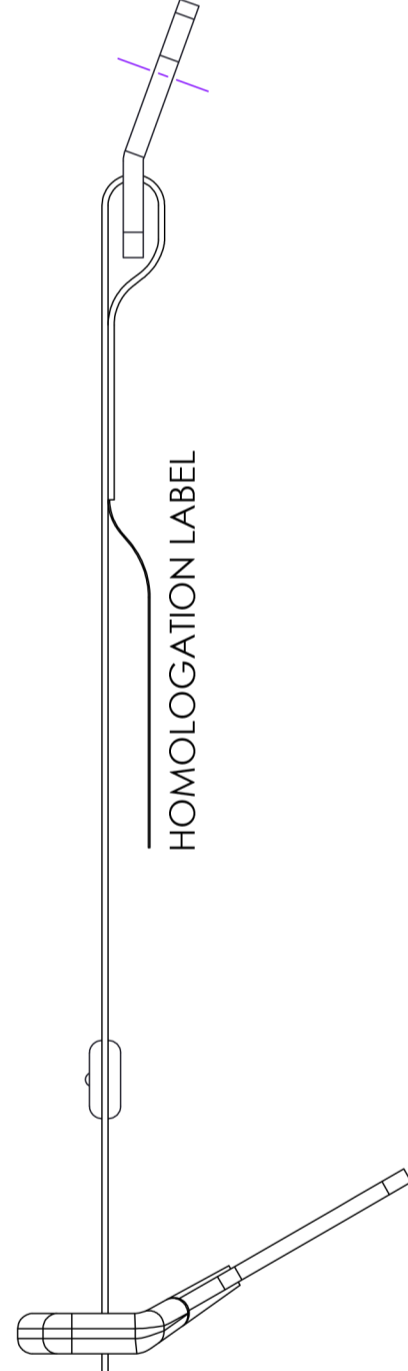

3

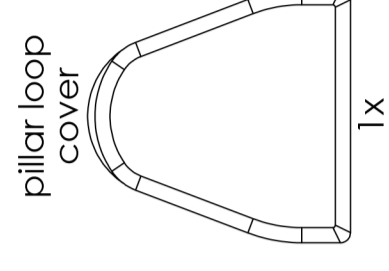
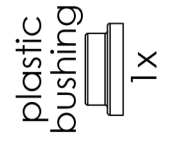
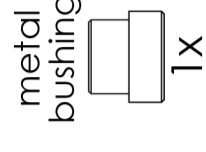
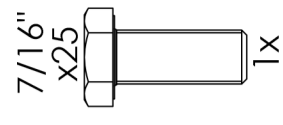
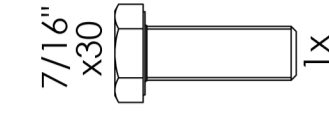
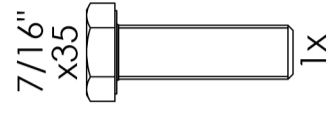
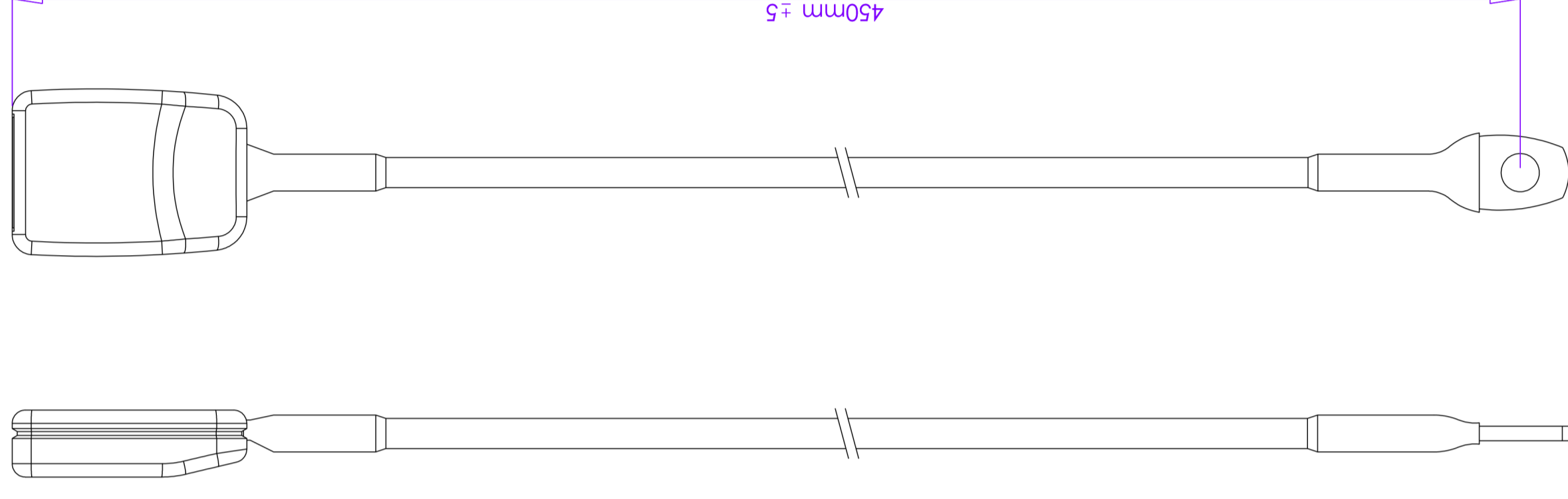

1

2